

MATCHED BY APPEARANCE

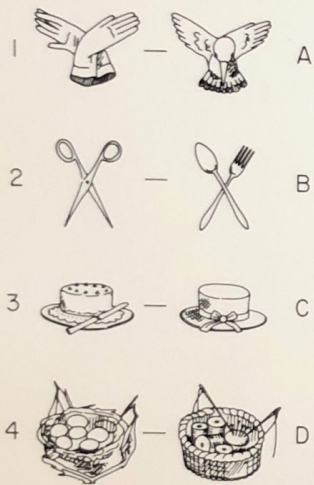

PAIRED BY FUNCTION

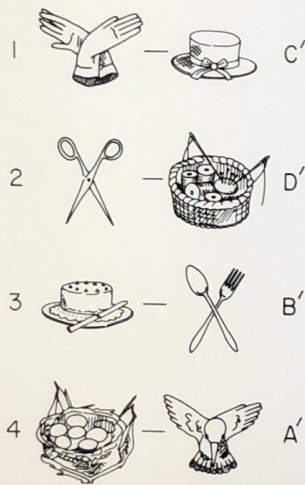

CHIMERIC STIMULI

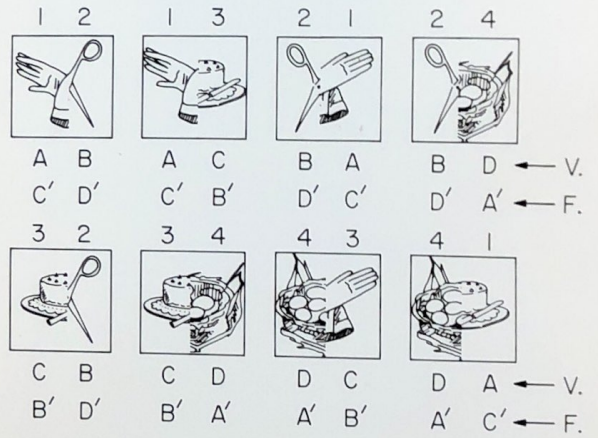

CLOCK
WITH
ROTATING
HAND



TWO-HANDED
STIMULI



CHOICE
TIMES

2:00 O'CLOCK

7:00 O'CLOCK

10:00 O'CLOCK

5:00 O'CLOCK

VERTICAL
MERIDIAN

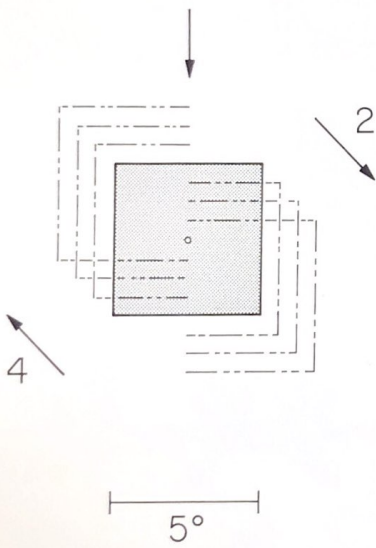

FOUR
DIRECTIONS
OF MOTION

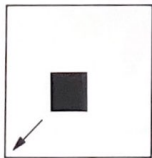
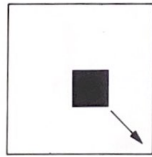
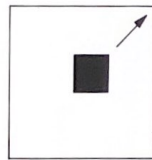

SPLIT-MOTION STIMULI

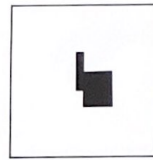

1 2



1 3



1 4

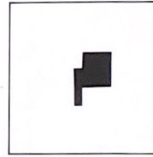

2 1



2 3



2 4

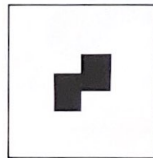

3 1

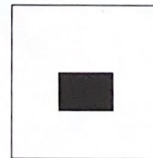

3 2

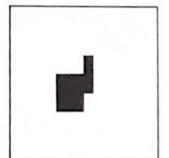

3 4

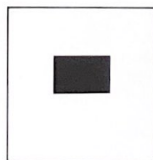

4 1

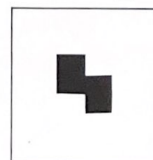

4 2

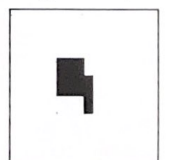

4 3

1.
"MOOSE"



2.
"ELK"

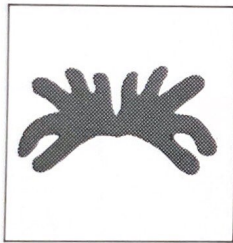

3.
"DEER"

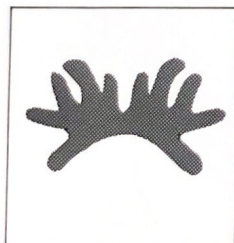

CHIMERIC STIMULI

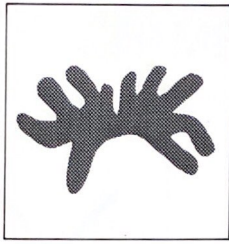

1 2

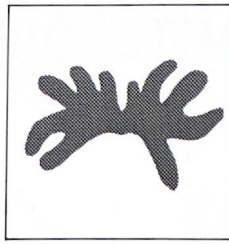

2 1

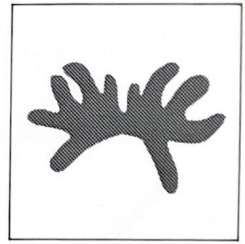

3 1

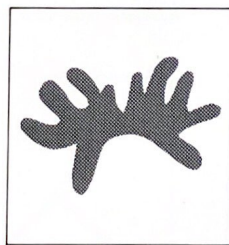

1 3

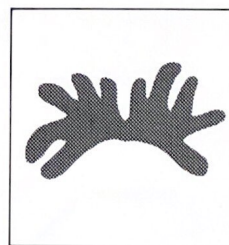

2 3

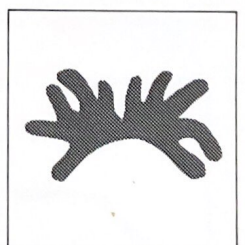

3 2

5°

ROTATING
FIGURE

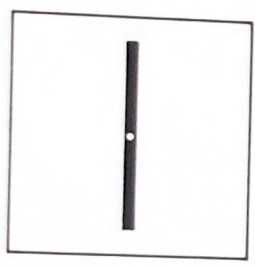

CHIMERIC STIMULI

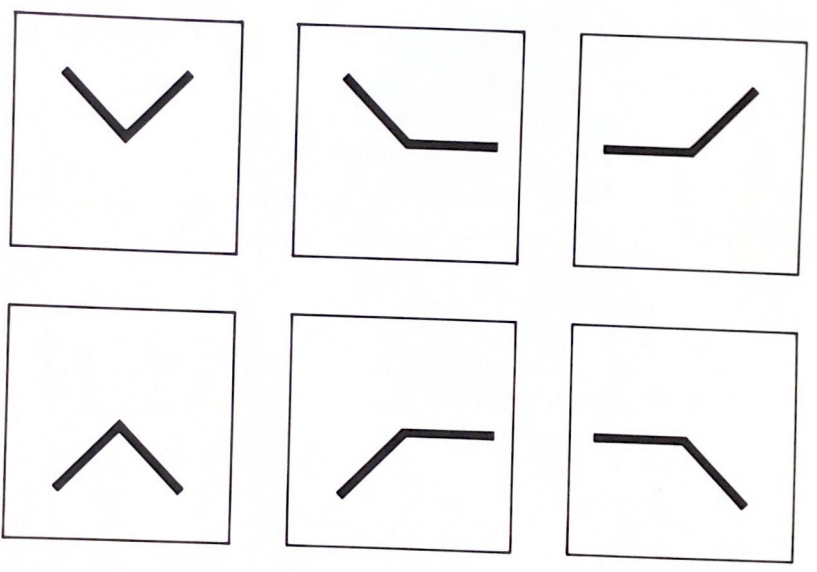

ROTATING
FIGURE

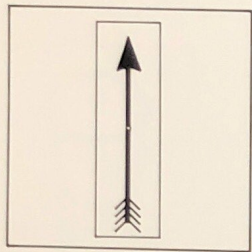

CHIMERIC STIMULI

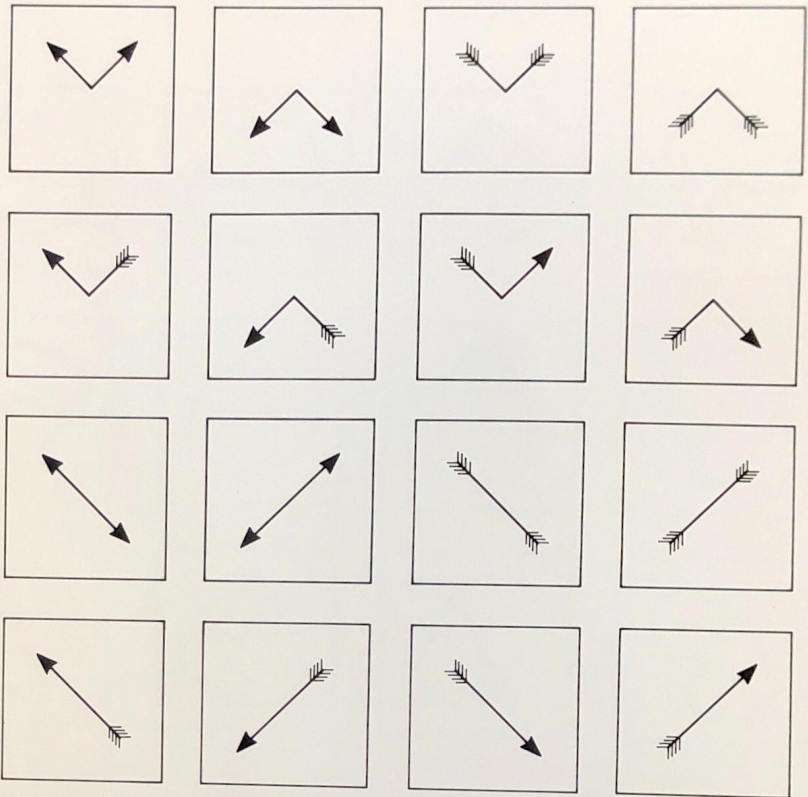

ROTATING
FIGURE

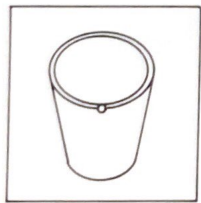

CHIMERIC STIMULI

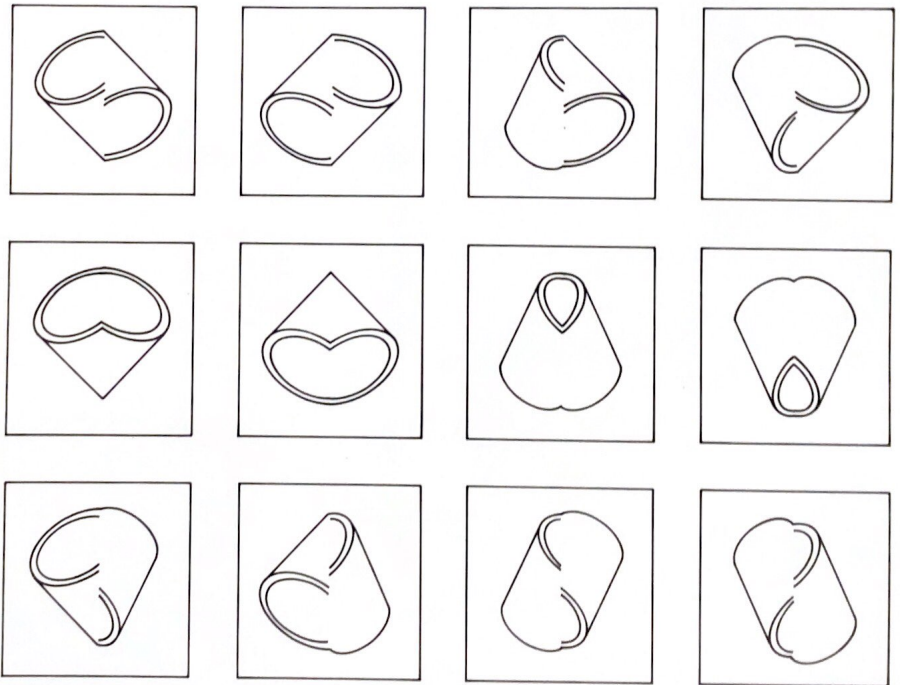

CHIMERIC STIMULI

1. *lady*



1 2



2 1



3 1

2. *ball*



1 3



2 3

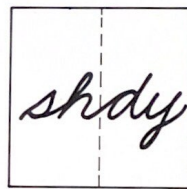

3 2

3. *shoe*

5°



1.



2.



3.